

# Multi-Purpose Hoop-It-All™

**Embroidery Field**  
(H 300 mm x W 180 mm)  
(H 11.8 inches x W 7.1 inches)

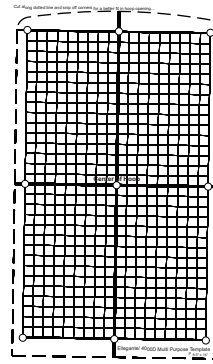

Alignment templates (2)

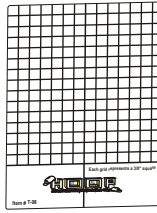
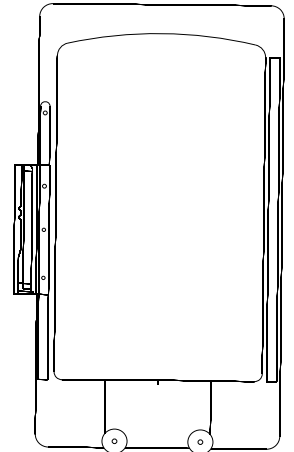

Multi-Purpose Hoop-It-All

**SIA™ Pressure  
-Sensitive Adhesive Tear-away**



**Fits BabyLock Ellegante  
Brother Innovis 4000D**

Hoop-It-All kit includes:

- Hoop-It-All™
- 2 Alignment templates
- 1 roll S-I-A™ Pressure-Sensitive Adhesive Tear-Away
- Special instructions

Embroidery Solutions  
**HOOP-IT-ALL™ INC.**  
www.hoopitall.com

Patent # 5,555,828 Patent # 2,179,119  
Other patents pending

## For Baseball/Golf caps and other difficult to Hoop Items!

### SIA™ Pressure Sensitive Adhesive tear-away stabilizer

The Hoop-It-All™ kit includes (1) roll of **SIA™ adhesive tear-away stabilizer**. This stabilizer is necessary for proper hoop function. The fabric is not held on the hoop with two rings. The SIA™ is attached to the back of the Hoop-It-All™ frame with the adhesive side facing up in the window area. The fabric is attached to the adhesive side holding it in place.

Using the Hoop-It-All™ prevents stretching of the fabric, which can distort and possibly damage the fibers in some fabrics increasing puckering. No ring marks are left on velvet, suede, or corduroy. Embroidery can be done anywhere on the garment without interference caused by seams, pockets, facings, zippers, buttons, etc.

Small items such as collars, cuffs, straps, socks, ties, and gloves can be placed directly on the **SIA™ adhesive tear-away stabilizer** and kept in place during the embroidery.

### S-dSV™ adhesive backed water soluble film

**S-dSV™** is used in place of the **SIA™ adhesive tear-away stabilizer** when embroidering on sheers and see-through fabrics and wherever the back of the fabric can be seen, such as scarves, collars, lapels, purse flaps, etc. This stabilizer completely disappears in tap water leaving no unsightly stabilizer or adhesive residue.

For future purchases of Hoop-It-All™ stabilizers, we will gladly refer you to a dealer in your area. If there are no stocking dealers in your area call our customer service department at (800) 947-4911 or visit our web site at [www.hoopitall.com](http://www.hoopitall.com).

### Placing & removing Hoop-It-All™ from embroidery arm.

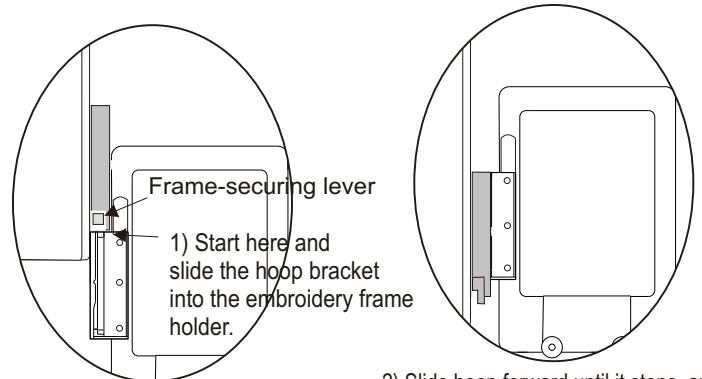

1) Start here and slide the hoop bracket into the embroidery frame holder.

2) Slide hoop forward until it stops, and lower the Frame-securing lever to be level with the frame to secure the Hoop-It-All™ frame in the embroidery frame holder.

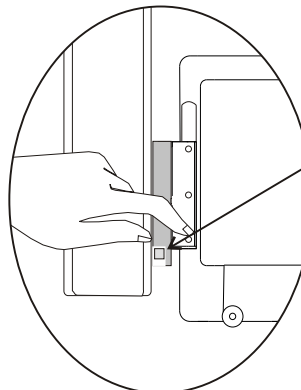

3) To remove the hoop off the machine's embroidery frame holder, raise the Frame-securing lever, and pull the Hoop-it-all™ frame toward you.

# Instructions For Caps -

## Preparation of Foam and Fused Backed Buckram Caps -

### Step 1

- Place Cap over your knee and with a water soluble marking pen and ruler mark the horizontal placement line.



- Place ruler vertically aligning edge with top seam front and mark the center placement line.



### Step 2

- Loosen the back strap to allow for flexibility.
- Turn hat over so that the visor is facing upside down.
- Staple or tape the sweat band to cap bill to prevent the embroidery from being stitched to it. Scraps of SIA™ can be used as tape.

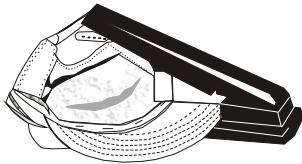

### Step 3

#### Preparing the Hoop-It-All™

- Place the Hoop-It-All™ on top of a flat surface face down.
- Cut a piece of SIA™ from the roll provided.
- Slowly peel back 2" to 3" of the release liner off the back of the SIA™ and attach the adhesive side down to the top of the hoop frame on the backside.
- Start pulling the release liner off while at the same time pressing the stabilizer to the sides and bottom.

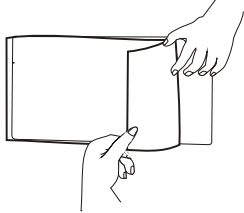

#### Making certain the SIA™ adhesive tear-away stabilizer is taut -

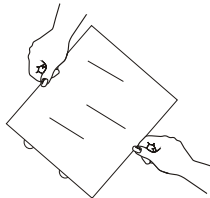

The SIA™ can be lifted and adjusted as needed and again pressed down to the hoop frame.

Pull taut sides (3) to (4)

### Step 4

- Now firmly rub and press the **SIA™ adhesive tear-away stabilizer** all around the entire backside of hoop frame making certain it adheres well.

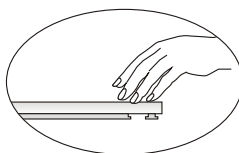

Carefully cut away any extra **SIA™ adhesive tear-away stabilizer** extending out from under the hoop frame with a rotary cutter.

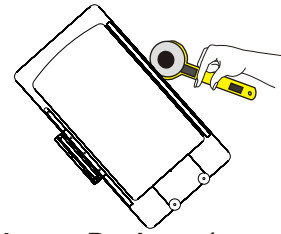

## Hats with Stand-up Loose Buckram (non-fused)-

- Cut the loose buckram liner about 1.5 inches on each side, where it is stitched to the visor. This allows the buckram liner to bend to the front visor easily.
- Pull firmly to front edge of visor and staple or tape together.

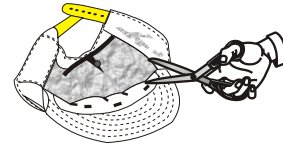

## Placement of Ball Cap on Hoop-It-All™ Frame -

- Loosen visor clamp nuts (spin knobs). (a)
- Slide ball cap visor under hoop clamp. (b)
- Attach template holes over studs on clamp plate. (see below).

### Place template holes over protruding studs on clamp plate.

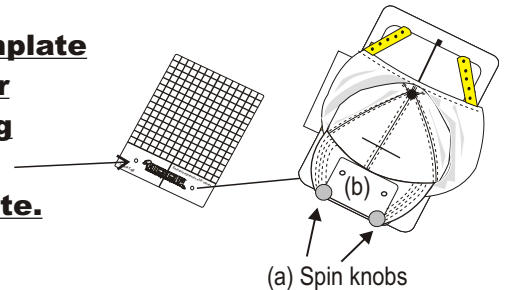

- Move cap forward and use one of the template horizontal lines to make certain the design will sew straight, and the template center vertical line for center placement.

### HINT: Mark a vertical center line directly on the SIA™ to help in placement of cap.

Spread open the cap and bring inside back seam to the vertical line marked on the SIA™ and Hoop-It-All™ frame.

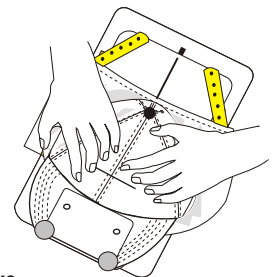

The backing on some caps may not adhere properly to the adhesive stabilizer. In this case spray ESA spray adhesive (Available through Hoop-It-All, Inc.) on the inside of the cap to increase the tack. Follow the instructions on back of the can.

## Placing hoop with Cap on embroidery arm.

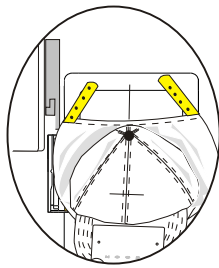

Attach hoop with cap affixed to the machine's embroidery arm. (See front page for instructions).

In the Embroidery EDIT Mode be sure to check the size of the design so that it fits properly in the space allotted. Resize if necessary. Use the arrow keys and bring the needle directly above the center cross lines. You are now ready to START.

## Removing the Cap from the Hoop -

After the embroidery is finished, loosen the clamp and carefully place both hands between the cap and the SIA™ stabilizer, and pull upward toward the center of the embroidery. This prevents excessive tearing of the SIA™ adhesive stabilizer. You need only patch the area torn for the next project.

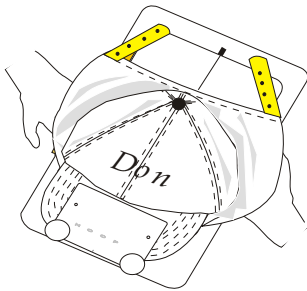

## Preparing for the next project -

- 1 - Cut a piece of SIA™ adhesive stabilizer large enough to overlap all around the torn area by one inch.
- 2 - Turn the hoop over and lightly attach the patch to the area to be covered. (fig 1)

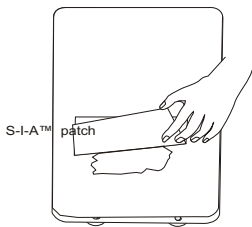

(fig 1)

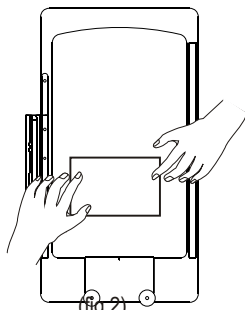

(fig 2)

3. Place hoop facing up on a flat surface and lay the shiny side of the release liner over the patched area. Firmly press down around the patch to make certain it is attached well on all sides.(fig 2)

The Multi-Purpose hoop can be used to embroider on small items, such as socks, ties, shoe tongues, belts, and similar items.

## Embroidering on Small Items

Mark placement lines directly on SIA™ adhesive stabilizer, as well as the fabric to guide you with positioning of the design.

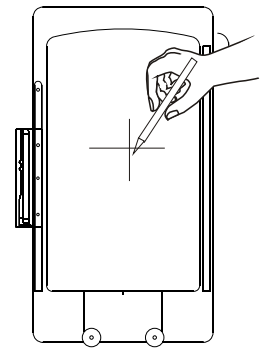

Place small items directly on the SIA™ adhesive stabilizer to coincide with the lines marked on the small item.

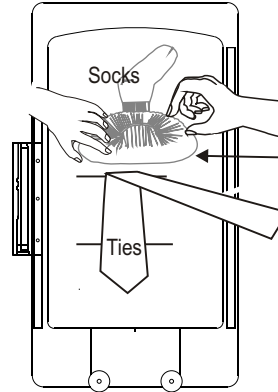

Spread open surrounding area and lightly finger press it to the SIA™.

In the Embroidery EDIT Mode of the machine size the designs and use arrow keys to bring to the small items. Embroider and remove as before. You can continue to patch the torn areas, as long as the SIA™ remains taut.

## Preparing to Embroider -

Even though the SIA™ is a stabilizer we recommend additional stabilizing in most cases. The following stabilizers have been developed by Hoop-It-All, Inc. There are many types and brands available on the market. Each package of Hoop-It-All stabilizers comes with complete instructions.

Before placing the fabric on the SIA™ adhesive tear-away stabilizer, with a hot iron press one layer of Hoop-It-All's FaBond™ temporary tear-away stabilizer to the back of the fabric. FaBond™ helps to further stabilize the fabric but is easily removed after the embroidery is finished. It also helps in removing the SIA™ from the back of the fabric leaving no unsightly stabilizer residue. The coating on FaBond™ helps in keeping the needle clean and free from any adhesive build-up on the needle. **Titanium needles are also recommended, to reduce any sticky build-up on the needle.**

In addition to the above we also recommend one layer of our dSV™ **water soluble film** be placed on top of the fabric. This film aids with further stabilizing the fabric, keeps high nap fabrics from interfering, and gives a nice dimension to the embroidery thread.

You also can use our S-dSV™ **"adhesive" water soluble film** in place of the SIA™ **adhesive tear-away stabilizer** when embroidering on sheer fabrics, making lace, and whenever the back of the fabric may be seen. It completely washes out in tap water within minutes.

Use **dry Cover-Up™ permanent vinyl stabilizer** as a topping to enhance embroidery by matching thread color. Keeps base fabric from showing through the embroidery, and prevents embroidery from sinking into high loft fabrics. It is also available in Clear.

## EMBROIDERING ON BULKY FABRICS.

It is normally difficult to properly align a large garment before embroidering with regular hooping methods.  
The following suggestions are possible solutions:

**Intended for unlined garments only. If you have a garment that is lined, remove lining first or baste securely to eliminate shifting and improper fitting after embroidery is complete.**

1 - Mark placement area cross lines with water soluble or air dry pen . (Test ink on area not visible to make sure it disappears). (a)

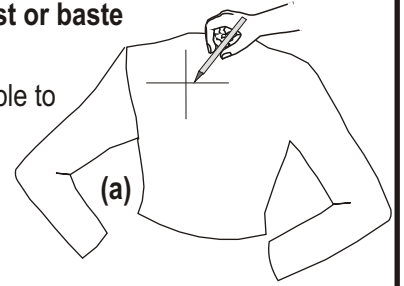

2 - **Before applying SIA™ to back of frame**, lay Hoop-It-All™ frame over marked area on garment and make sure the vertical line meets with line marked on hoop frame. (b)

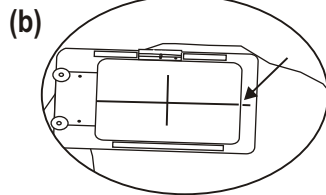

3 - Trace all the way around hoop's inner edge with a water soluble pen. (c) The rectangle you draw will be used later to guarantee proper placement in hoop.(d)

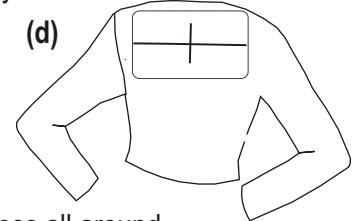
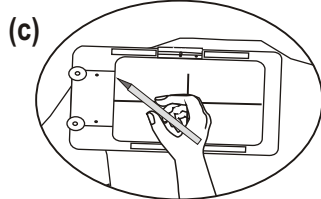

4 - Lay hoop face-down on flat surface and attach **SIA™** firmly to backside. (e) Hand press all around back of hoop, making certain it adheres securely to back of hoop frame.

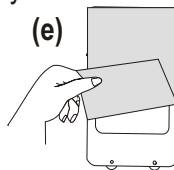

5 - Turn hoop face-up on flat surface(f).

6- Mark the placement lines on adhesive side of **SIA™** stabilizer(g).

7- Use lines marked on frame as a guide to keep your design straight.

8 - Spread garment open and place marked area over hoop.

9 - Use your finger tips to feel inner edges of hoop frame and line-up the rectangle you traced in **step-2** so that it fits within the hoop frame and the vertical line you drew lines up with mark on frame.

7 - If you have a light box and it is possible to see through the fabric, place box under the Hoop-It-All™. The placement lines are now visible. Lightly place the fabric area to be embroidered on the hoop matching the lines marked on the fabric with those marked on the **SIA™**. When sure of the placement, smooth fabric with your hands to the adhesive until it adheres well.

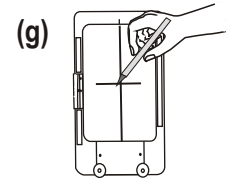
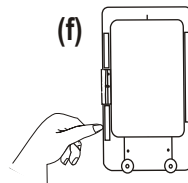

### Helpful Hints:

1) If you do not have a light box, insert a pin through the center marked on your fabric and continue to stick the pin through the center marked on the **SIA™**. (h) Gently spread the fabric to the right and place the pin through the horizontal outer right lines marked on the fabric and **SIA™**. Repeat these steps on left, upper and lower lines. Then hand press the fabric carefully to the **SIA™** so it lies flat and adheres well to the stabilizer.

2) Other non-adhesive Hoop-It-All stabilizers such as **TAS™**, (tear-away) or **dSV™** (water soluble) can be placed under the hoop when needed to prevent any possible puckering . Be careful that no loose fabric gets in the way of the needle and the embroidery area or behind the hoop.

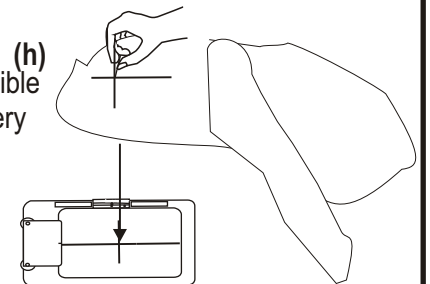

**HIA** Embroidery™  
Solutions

www.hoopitall.com

**HOOP-IT-ALL** INC.

7200 East Second Street-Bldg A - Prescott Valley, Arizona 86314 - 928-775-6604