

Patent # 5,555,828 & # 2,179,119
Other patents pending

**Brother 270D, 300, 400, 500
Babylock Intrigue**

Hoop-It-All kit includes:

- Hoop-It-All™
- Placement template
- SIA™ Adhesive stabilizer Tear-away sample sheets
- Special instructions

Embroidery Solutions
HOOP-IT-ALL INC.

www.hoopitall.com

For Baseball/Golf caps and other difficult to Hoop Items!

ADHESIVE STABILIZERS BY HOOP-IT-ALL, INC.

SIA™ adhesive tear away stabilizer

The Hoop-It-All™ kit includes, SIA™ adhesive stabilizer sample sheets. This stabilizer is a necessary item for proper hoop function. It holds the fabric in place during embroidery, instead of two rings used with ordinary embroidery hoops.

No stretching is necessary which can distort and possibly damage the fibers in some fabrics increasing puckering. No ring marks are left on velvet, suede, or corduroy. Embroidery can be done anywhere on the garment without interference caused by seams, pockets, facings, zippers, buttons, etc.

Small items such as collars, cuffs, straps, socks, ties, and gloves can be placed directly on the SIA™ and kept in place during the embroidery.

S-dSV™ adhesive water soluble stabilizer

S-dSV™ is for use with the Hoop-It-All™ in place of the SIA™ adhesive tear away stabilizer when embroidering on sheers and see-through fabrics and wherever the back of the fabric could be seen, such as scarves, collars, lapels, purse flaps, etc. This stabilizer completely dissolves in warm water leaving no unsightly stabilizer or adhesive residue.

For future purchases of Hoop-It-All™ stabilizers, we will gladly refer you to a dealer in your area. If there are no dealers in your area call our customer service department at (800) 947-4911 or visit our web site at www.hoopitall.com.

Placing & removing Hoop-It-All™ from embroidery arm.

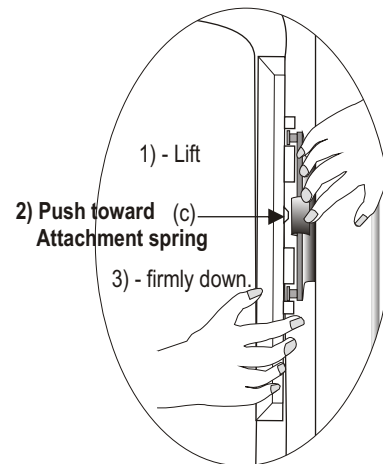

1. Lift and line up the hoop Sliding Bracket guides with the machine's embroidery carriage frame holder.
2. As you bring the Sliding Bracket to the carriage frame holder, push it against the spring and push down firmly.
3. To remove the bracket, support the embroidery arm of the machine with one hand and gently lift the front and then the back of the mounting bracket off.

NEED ASSISTANCE?
Want to know more about Hoop-It-All products?
Call your local dealer or
our Customer Service Department
for more information:
1-800-947-4911

Instructions For Caps -

Preparation Foam and Fused Backed Buckram Caps -

Step 1

- Place Cap over your knee and with a water soluble marking pen and ruler mark the horizontal placement line directly on front of cap (fig 1).

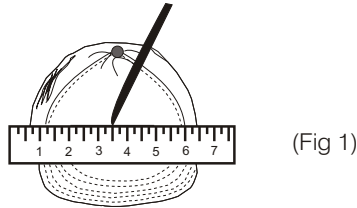

(Fig 1)

- Place ruler vertically aligning edge with top seam front and mark the center placement line (fig 2).

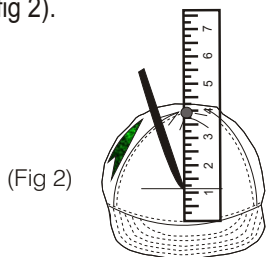

(Fig 2)

STEP 2

- Loosen the back strap to allow for flexibility.
- Turn hat over so that the visor is facing upside down.
- Staple or tape the sweat band to cap bill to prevent the embroidery from being stitched to it (fig 3). Scraps of SIA™ can be used as tape.

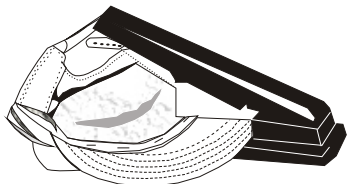

(Fig 3)

Preparation of Hoop-It-All™ -

STEP 3

- Use fingernail to pull one corner of the adhesive stabilizer off the release liner.
- Separate SIA™ from shiny backing paper (release liner) about 2 inches across one end.
- Place the sticky side along the top edge of hoop allowing 1/8" of the SIA™ to curl over the edge. Smooth and **firmly** press down.
- Grasp the shiny backing paper and pull toward the other end of hoop.
- Place and press the SIA™ evenly along the sides and bottom of hoop so it remains taut during the embroidery. Be sure to **Firmly** press SIA™ on hoop to prevent it from pulling loose and causing puckering of the fabric. (Fig 4)

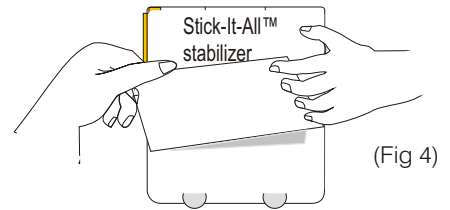

(Fig 4)

Hats with Stand-up Loose Buckram (non -fused)

Follow step 1

STEP 2

- Cut the loose buckram liner about 1.5 inches on each side, where it is stitched to the visor. This allows the buckram liner to bend to the front visor easily. (Fig 5)
- Pull firmly to front edge of visor and staple or tape together.

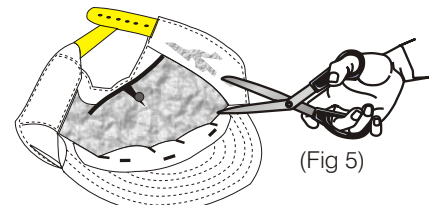

(Fig 5)

Placement of Prepared Cap under Clamp -

STEP 2

- Loosen visor clamp nuts (spin knobs (a)). (Fig 6)
- Slide visor under clamp.
- Move cap forward until visor hits screws or cap front hits front edge of clamp, or is properly aligned. Tighten spin knobs.

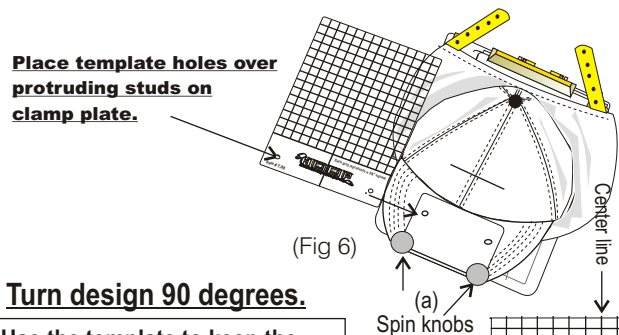

(Fig 6)

Turn design 90 degrees.

Use the template to keep the design centered and straight. The long vertical center mark on the template and the 8th line from the top is approximately right. Use them as a guide, re-move the template and then use the cursor keys on machine to bring the needle to the center marked on the cap front.

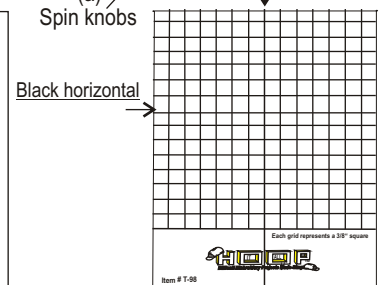

(Fig 7)

STEP 3

- Press cap down against the adhesive backing starting in the middle and working out toward the edges.
- Carefully lift edge of visor on the right side and tuck the panel fabric under the visor against the adhesive. Repeat on the left side.

Spread open the cap and bring inside back seam to the vertical line marked on the top of the Hoop-It-All™ (fig 7).

The backing on some caps may not adhere well to the adhesive stabilizer. We then recommend using **ESA spray adhesive** on the inside of the cap to increase the tack. Follow the instructions on back of the can. (Available through Hoop-It-All, Inc.)

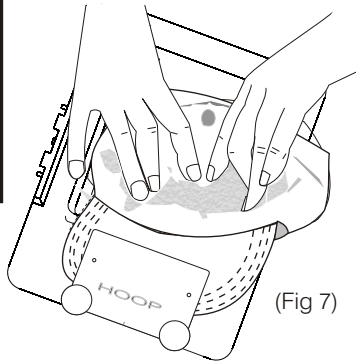

(Fig 7)

Use **Chip clips** to hold down outer edge of cap, if needed. (Fig 8)

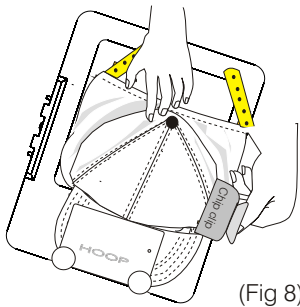

(Fig 8)

DESIGN MUST BE TURNED 90 DEGREES WHEN EMBROIDERING ON CAPS.

STEP 4

After the embroidery is finished, loosen the clamp and carefully place both hands between the cap and the SIA™ stabilizer pulling upward toward the center of the embroidery (fig. 9). This prevents excessive tearing of the SIA™ adhesive stabilizer. You need only patch the area torn for the next project.

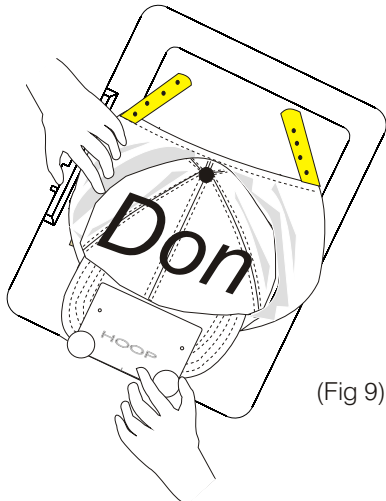

(Fig 9)

HOW TO PREPARE FOR THE NEXT PROJECT:

- 1 - Cut a piece of SIA™ adhesive stabilizer large enough to overlap all around the torn area by one inch.
- 2 - Turn the hoop over and lightly attach the patch to the area to be covered. (Fig 10)

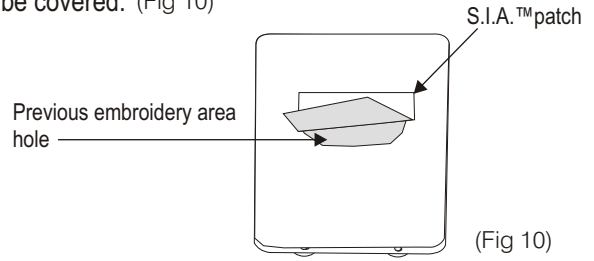

(Fig 10)

- 3 - Place hoop facing up on a flat surface and lay the shiny side of the release liner over the patched area. Firmly press down around the patch to make certain it is attached well on all sides. (Fig 11)

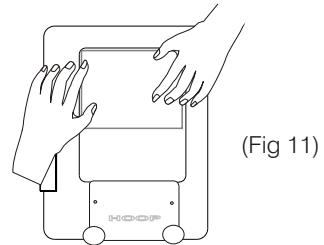

(Fig 11)

Embroidering on Small Items

Mark center lines directly on SIA™ adhesive stabilizer. (Fig 12)

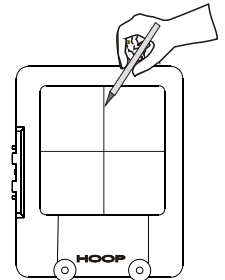

(Fig 12)

Place small item directly on the SIA™ adhesive stabilizer so that it is centered with the lines marked on it. Spread open surrounding area pressing it to the SIA™. (Fig 13)

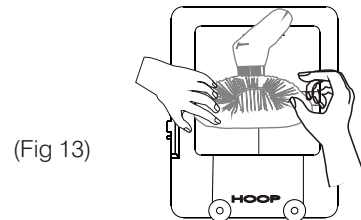

(Fig 13)

The SIA™ holds the item in place while you embroider. (Fig 14)

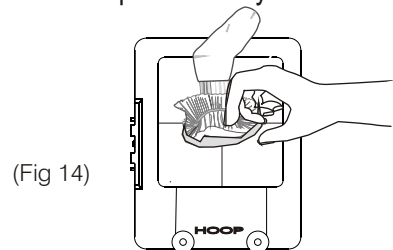

(Fig 14)

Gently remove the item off the SIA™ adhesive stabilizer.

EMBROIDERING WITH BULKY FABRICS. It is difficult to properly align a large garment before embroidering by regular hooping methods. The following suggestions are possible solutions:

1 - Mark placement area with water washable pen.



2 - Put Hoop-It-All™ frame on top of marked area on garment. Then trace around the inside of the hoop with a water soluble pen.

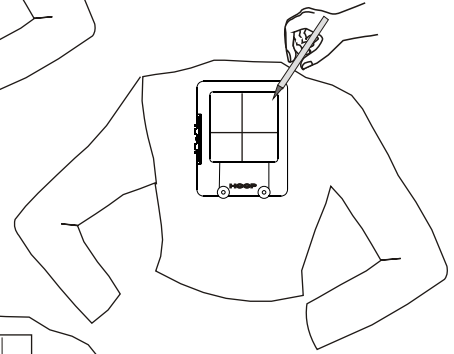

3 - Remove hoop frame from off the garment..

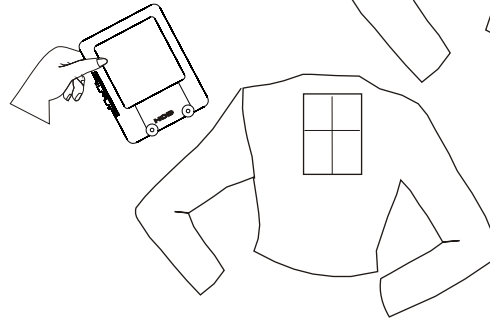

4 - Lay hoop face down on a flat surface and attach SIA™ to the backside. Hand press all around the back of hoop to make certain the adhesive stabilizer is adhering well to the entire bottom.

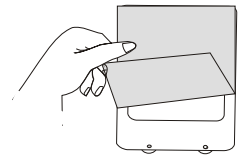

5 - Turn hoop face up on flat surface SIA™ stabilizer. Use the

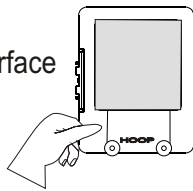

and mark the placement lines marked lines on frame as a

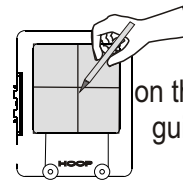

guide.

6 - Spread the garment open and place the marked area over the hoop. With your finger tips feel the traced area all around the inner opening of the frame.

7 - If you have a light box and it is possible to see through the fabric, place the box under the Hoop-It-All™. The placement lines are now visible. Lightly place the fabric area to be embroidered on the hoop matching the lines marked on the fabric with those marked on the SIA.™. When sure of the placement, smooth the fabric to the adhesive starting from the center of the fabric until it adheres well.

8 - If you do not have a light box, insert a pin in the center marked on your fabric and continue to stick the pin into the center marks on the SIA.™. Gently spread the fabric to the right and place the pin on the horizontal lines marked on the fabric and SIA.™. Repeat on the left side and upper and lower vertical lines marked on fabric and SIA.™. Then press the fabric carefully so it lies flat and adheres well to the SIA.™ stabilizer.

Remember to turn your design 90 degrees when fabric is placed on hoop with bracket on top.

9. Be careful that no loose fabric gets in the way of the needle and the embroidery area.

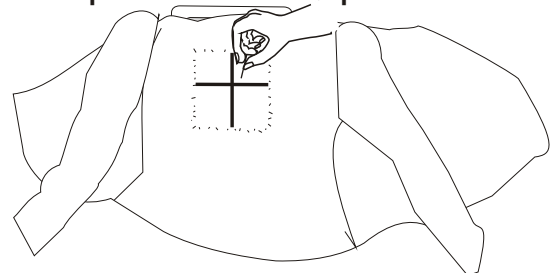

7200 East Second Street-Bldg A - Prescott Valley, Arizona 86314 - 928-775-6604